



TANA Spot HCRI Fixture Guide



Indoor | Surface | Output up to 257lm/module



Key applications

- ✓ Cabinet/Furniture
- ✓ Display case
- ✓ Interior
- ✓ Retail display
- ✓ Shelving display

Key features

- ✓ CRI 90+
- ✓ IP40
- ✓ Lensed

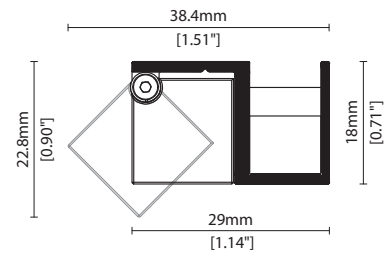



TANA Spot HCRI

Specification sheet

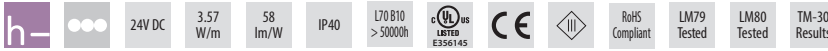

Dimensions	H18/W29/L120mm (H0.71/W1.14/L4.72in)
PCB Cut-point	-
LED Pitch	15mm (0.59in) - 3 LED per fixture
Chip	h-line: CREE/Lumileds
Cover/Optics	26°
CCT	h-line: 2700K/3000K
LED binning	h-line: 3-step MacAdam Ellipse
CRI	≥ 90
Lifetime	50,000 hours @ 25°C (50,000 hours @ 77°F)
Operating temp	T _a = -25 to 50°C (T _c max = 86.1°C) @ T _a = 25°C (T _c = 61.1°C) T _a = -13 to 122°F (T _c max = 187°F) @ T _a = 77°F (T _c = 142°F)
IP Rating	IP40
Finish	Silver anodised
Mounting	Surface mounting via screw fixing
Power feed	Male/female connectors
Control	Non-dimmable



Power consumption	Supply voltage	Supply current
3.57W	24V DC	0.15A

26° Lens		CRI	R9	Rf	Rg
h-line	257lm/module 72lm/W	93	77	-	-

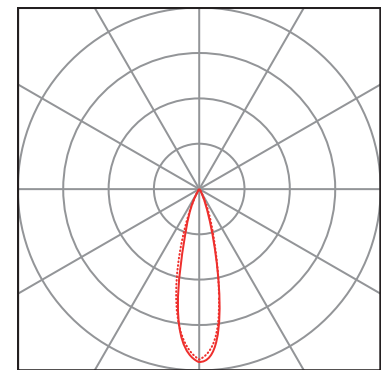
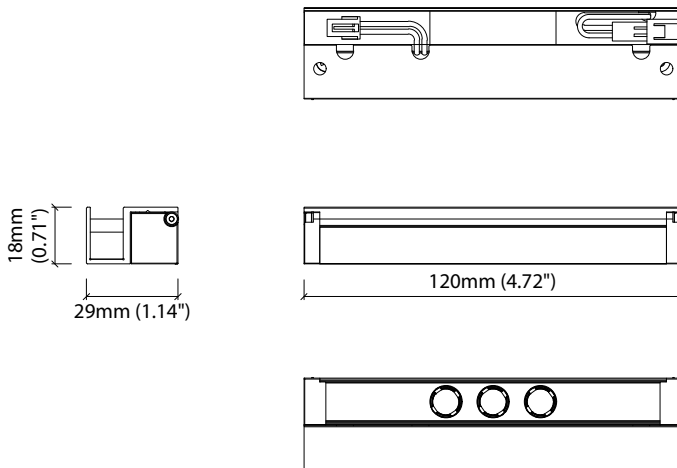

26° Lens
— C0 / C180 cd / 1000 lm C90 / C270

Data derived from independent UKAS / IESNA LM-79-08 accredited testing of production samples.



TANA Spot HCRI Code Table



FIXTURE

Model	Finish	Grade	LED	Colour (CCT)	IP	Power Feed ¹	Fixing	Lens	Input
TANA Spot TA	Silver Anodised SA	h h	TANA Spot HCRI 109	2700K 27	IP40 40	Single no sheath IP20 connector S20X	Screw Fixed SF	26° lens 26	DC 24V g
	Black anodised BA			3000K 30		Double no sheath IP20 connector D20X			

¹ Refer to **Power Feed Options** on **Options** pages

Code Example:

TA	-	SA	-	h	-	109	-	30	-	40	-	S20X	-	SF	-	26	-	g
TANA Spot		Silver Anodised		h		TANA Spot HCRI		3000K		IP40		Single no sheath IP20 connector		Screw Fixed		26° lens		DC 24V

LED ENGINE VARIANTS

Luminaire	LED	CRI	Lumen/module	W	Spec Doc
TANA Spot	108	≥ 80	260/module	3.57	TANA Spot
TANA Spot HCRI	109	≥ 90	257/module	3.57	TANA Spot HCRI

* Performance data: h-line, 26° lens, 2700K

POWER FEED OPTIONS

* Options are an integral part of the fixture ordering codes. Please refer to **Code Table** pages.

S20X Single no sheath IP20 connector

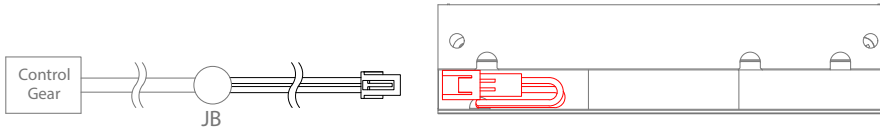

D20X Double no sheath IP20 connector

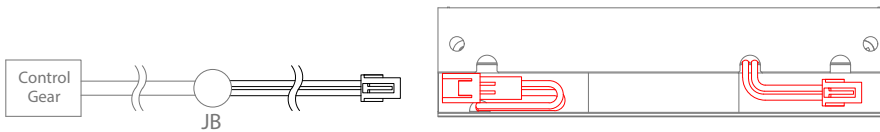

Key

Control Gear Power supply, sub-controllers & control systems

JB Junction box / cable connection

POWER FEED

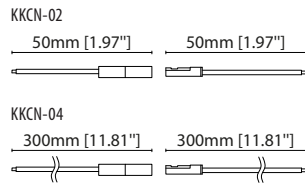
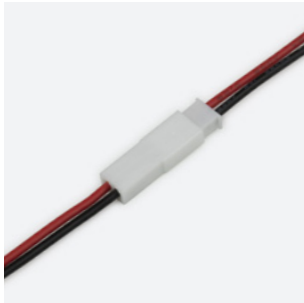

KKCN-02 50mm (1.97in) pair
KKCN-04 300mm (11.81in) pair
2 PIN male + female JST connector set

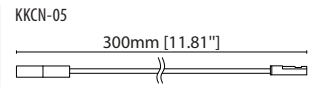

KKCN-05
2 PIN 300mm (11.81in) extension lead (JST)

KKDC CONTROL



IP20
Plastic housing
L170/W59/H29mm
(L6.69/W2.32/H1.14in)

KKDM-06 1-10V
visDIM dimmable sub-controller
(4 x 8A max @ 12-36V)



IP20
Plastic housing
L170/W53.4/H28mm
(L6.69/W2.10/H1.10in)

KKSC-05 DMX
visDIM dimmable sub-controller
(4 x 5A max @ 12-36V)



IP20
Plastic housing
L170/W59/H29mm
(L6.69/W2.32/H1.14in)

KKDL-02 DALI
visDIM dimmable sub-controller
(4 x 8A max @ 12-36V)



IP20
Plastic housing
L166/W53.4/H23mm
(L6.54/W2.10/H0.91in)

KKDL-03 DALI
visDIM dimmable sub-controller
(4 x 5A max @ 12-36V)



TANA Spot Driver/PSU Options



AVAILABLE PSU OPTIONS

Control Mode	PSU (Order Code)	Input Voltage AC	Output Voltage DC	Rated Output Current	Rated Power	Dim %	IP Rating
Switched	CEN-60-24	90-295V	24V	2.5A	60W	-	IP67
	HLG-60H-24	90-305V	24V	2.5A	60W	-	IP67
	HLG-100H-24	90-305V	24V	4.0A	100W	-	IP67
	HLG-150H-24	90-305V	24V	6.3A	150W	-	IP67
	HLG-240H-24	90-305V	24V	10A	240W	-	IP67
0-10V (1-10V)	PWM-40-24	90-305V	24V	1.67A	40W	100-0.15 (100-10)	IP67
	PWM-60-24	90-305V	24V	2.5A	60W	100-0.15 (100-10)	IP67
	PWM-90-24	90-305V	24V	3.67A	90W	100-0.15 (100-10)	IP67
	PWM-120-24	90-305V	24V	5.0A	120W	100-0.15 (100-10)	IP67
DALI	LIN100A1	120-277V	24V	1A per channel	100W	100-0.1	IP66/IP40
DMX RGB	LIN100A1	120-277V	24V	1.33A per channel	100W	100-0.1	IP66/IP40
DMX RGBW	LIN100A1	120-277A	24V	1A per channel	100W	100-0.1	IP66/IP40

Flicker Free Options - Combination of PSU+ sub-controller

Control Mode	PSU (Order Code)	Sub-controller (Order Code)	Input Voltage AC	Output Voltage DC	Rated Output Current	Rated Power	Dim %	IP Rating PSU/ Sub-controller
0-10V or 1-10V	CEN-60-24	KKDM-06	90-295V	24V	2.5A	60W	100-0.9	IP67/IP20
	HLG-60H-24	KKDM-06	90-295V	24V	2.5A	60W	100-0.9	IP67/IP20
	HLG-100H-24	KKDM-06	90-295V	24V	4.0A	100W	100-0.9	IP67/IP20
	HLG-150H-24	KKDM-06	90-295V	24V	6.3A	150W	100-0.9	IP67/IP20
	HLG-240H-24	KKDM-06	90-295V	24V	10.0A	240W	100-0.9	IP67/IP20
DALI	CEN-60-24	KKDL-02/03	90-295V	24V	2.5A	60W	100-0.1	IP67/IP20
	HLG-60H-24	KKDL-02/03	90-305V	24V	2.5A	60W	100-0.1	IP67/IP20
	HLG-100H-24	KKDL-02/03	90-305V	24V	4.0A	100W	100-0.1	IP67/IP20
	HLG-150H-24	KKDL-02/03	90-305V	24V	6.3A	150W	100-0.1	IP67/IP20
	HLG-240H-24	KKDL-02/03	90-305V	24V	10.0A	240W	100-0.1	IP67/IP20
DMX RGB	CEN-60-24	KKSC-05	90-295V	24V	2.5A	60W	100-0.9	IP67/IP20
	HLG-60H-24	KKSC-05	90-305V	24V	2.5A	60W	100-0.9	IP67/IP20
	HLG-100H-24	KKSC-05	90-305V	24V	4A	100W	100-0.9	IP67/IP20
	HLG-150H-24	KKSC-05	90-305V	24V	6.3A	150W	100-0.9	IP67/IP20
	HLG-240H-24	KKSC-05	90-305V	24V	10.0A	240W	100-0.9	IP67/IP20

¹ The items shown above cover the most frequently used specification but does not exhaust the possible options

² PSU and/or driver can be chosen from the table, or KKDC may recommend the best option upon receipt of the controls requirement and installation environment

³ Electrical shop drawing will include detailed information of PSU and relevant control drivers

⁴ Cut sheets are available on the controls section of www.kkdc.lighting or upon request